

ELETTROBAR

**SPARE PARTS CATALOGUE
ERSATZTEILKATALOG
CATALOGUE PIECES DETACHEES
CATALOGO PARTI RICAMBIO
CATALOGO DE PIEZAS DE RECAMBIO
CATALOGO PEÇAS DE REPOSIÇÃO**

Mistral 51

18-02-2005

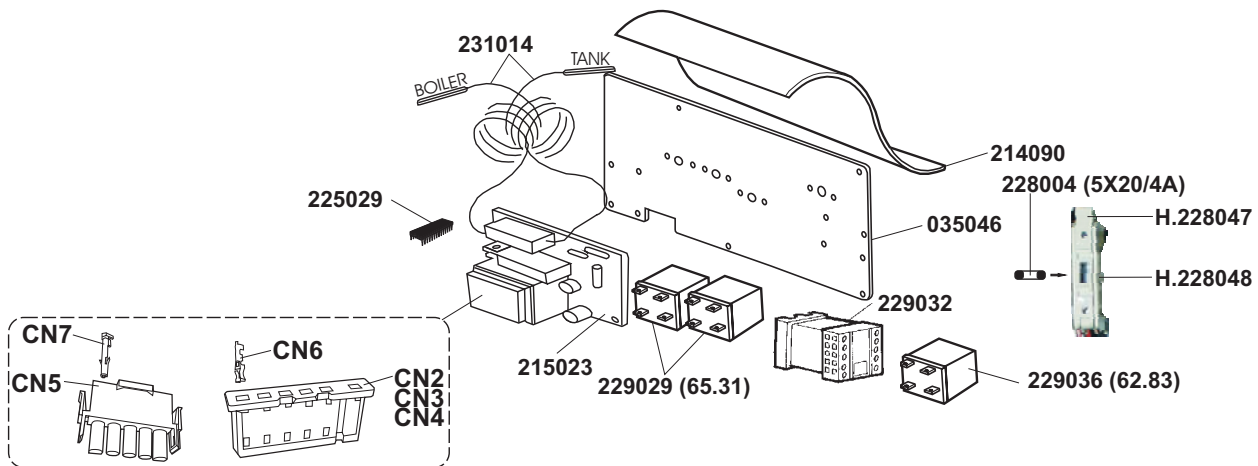
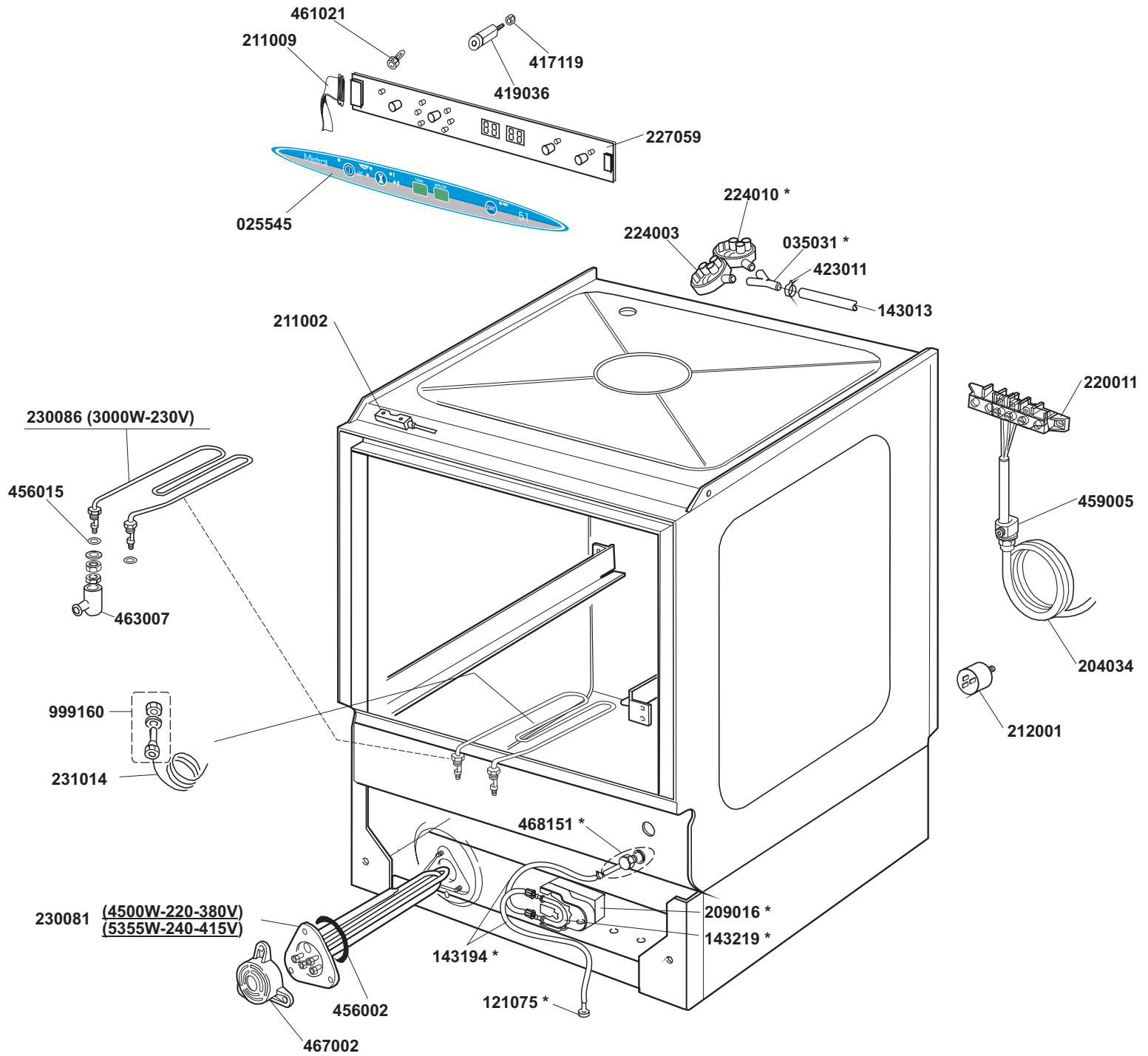

*Optional

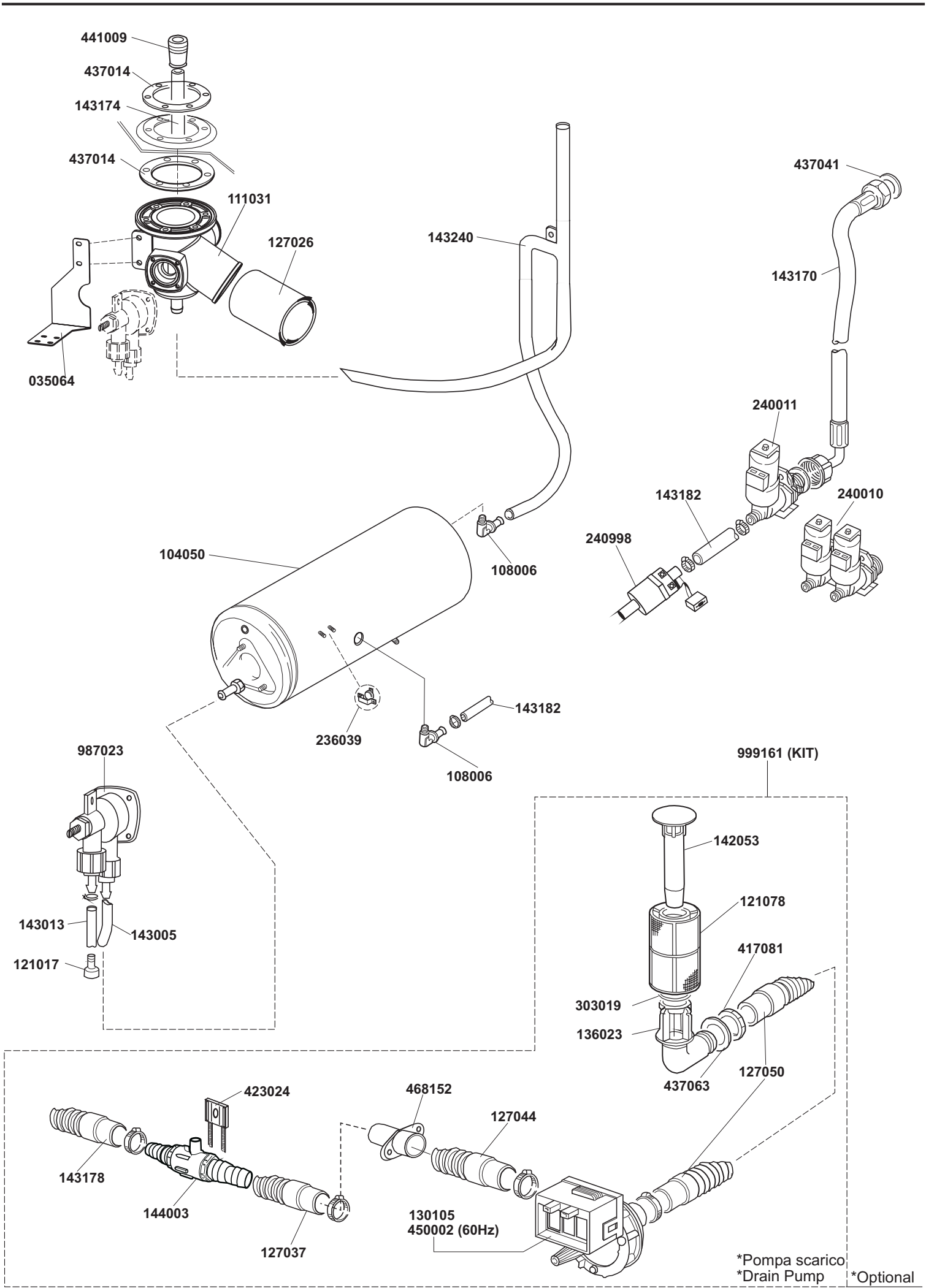

*Pompa scarico
*Drain Pump *Optional

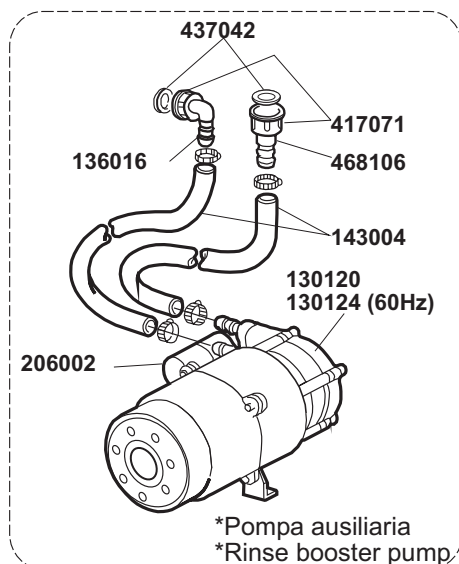
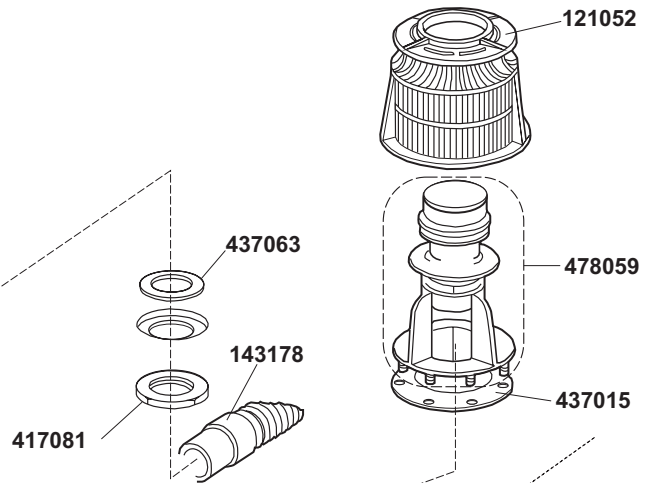
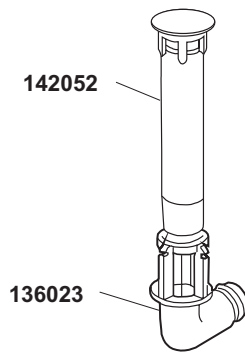
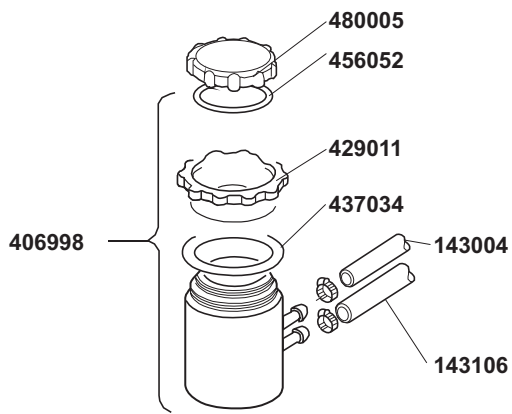
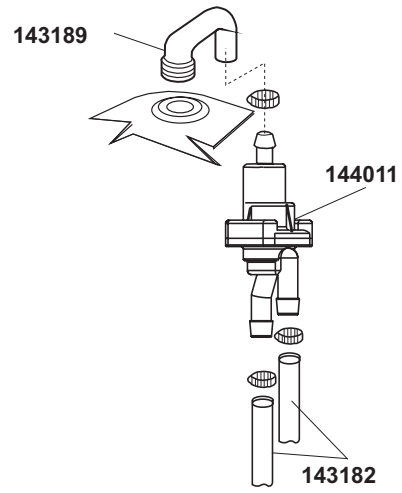
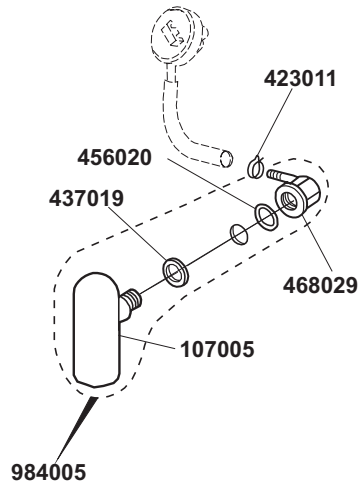
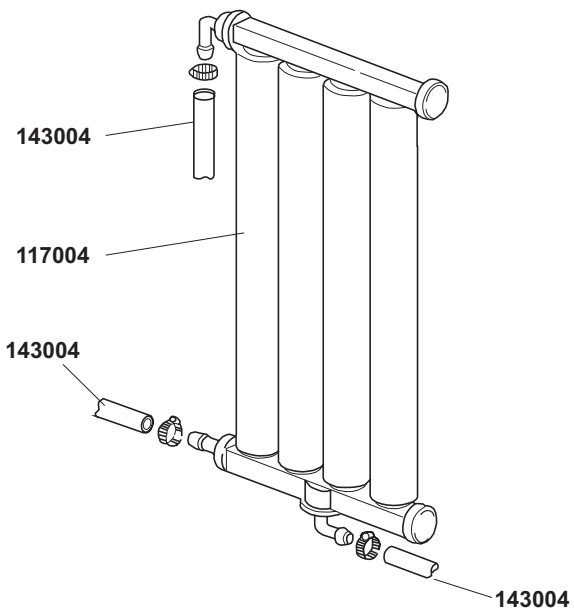

*Pompa ausiliaria
*Rinse booster pump

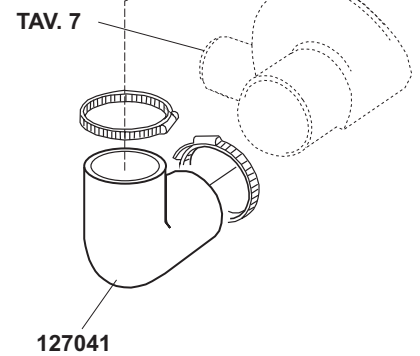

*Optional

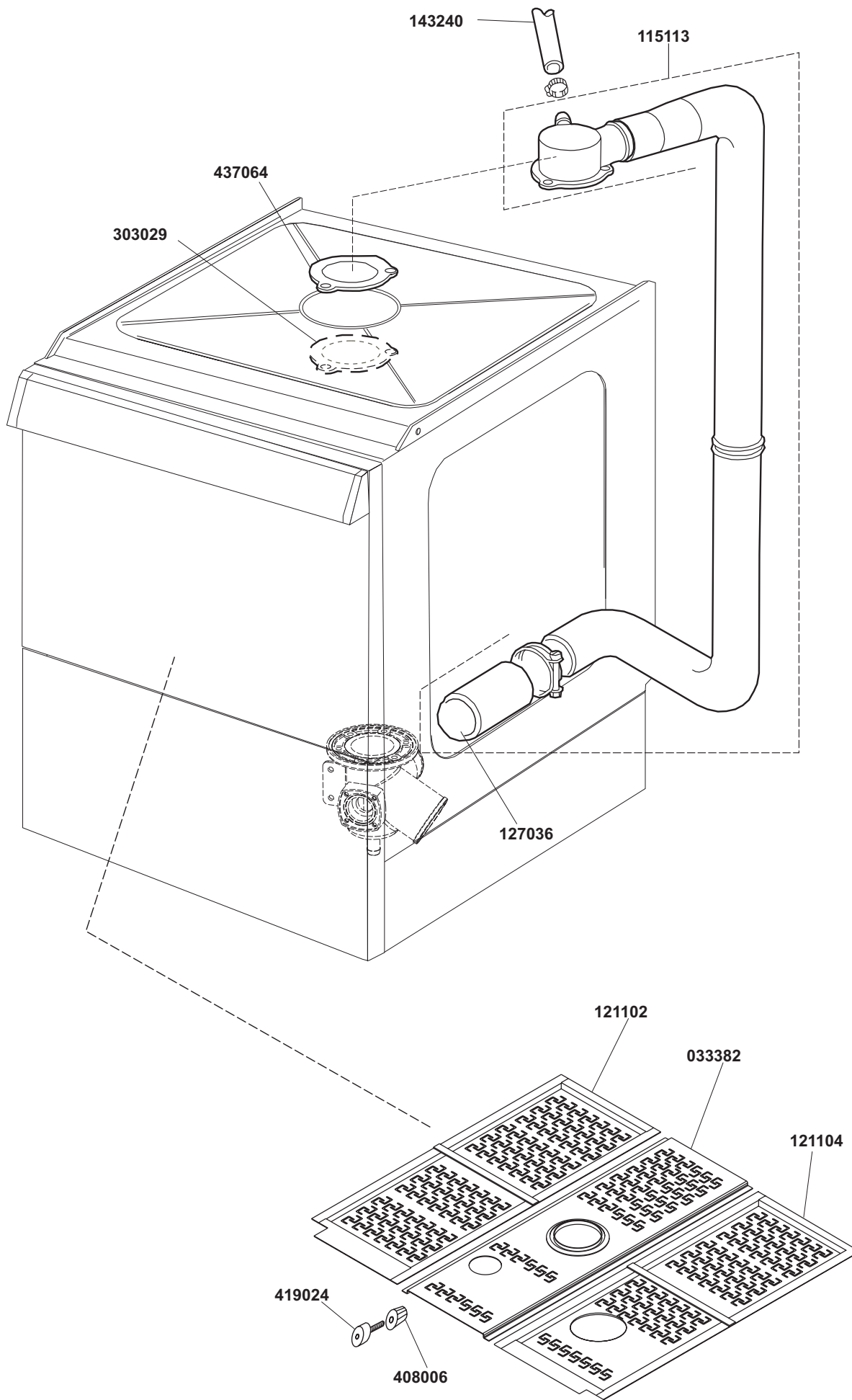

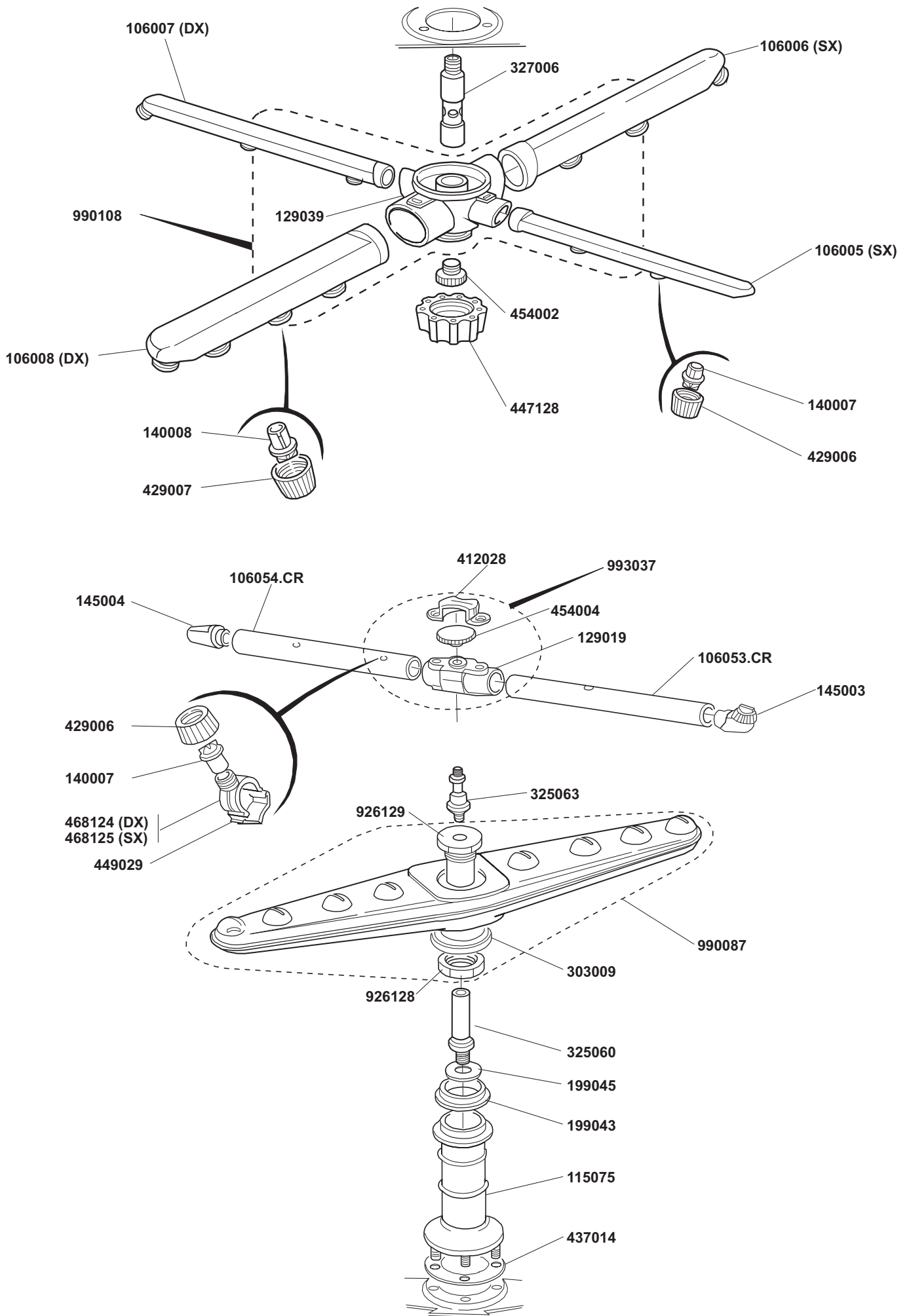

130126 (230V- 50Hz)
130133 (230V- 60Hz)

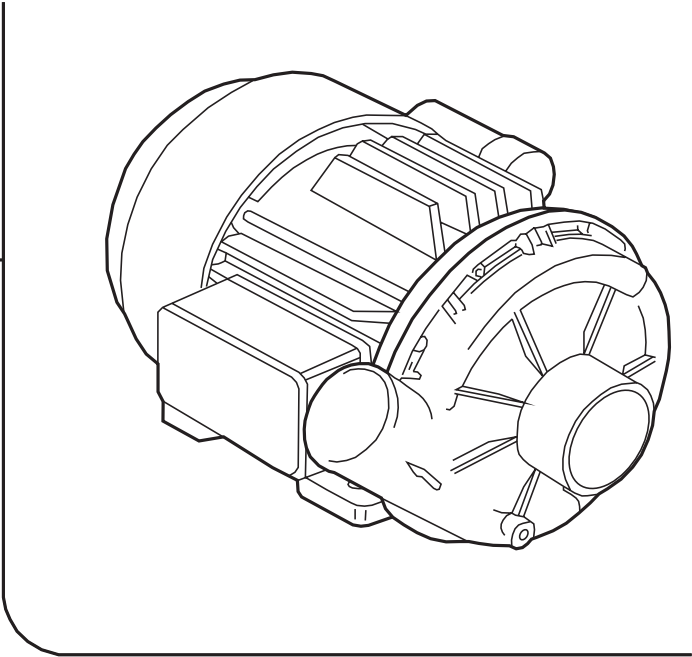

206004

314001

313012

926080

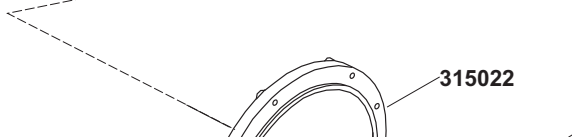

315022

456031

124031
124053 (60Hz)

116019

141007

T. 175